

Expertise in explosion protection

05.2011

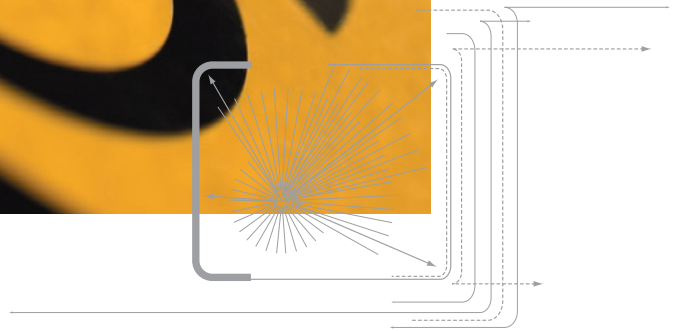

Partner of Experts

STAHL
CraneSystems



STAHL CraneSystems – The Experts



ATEX

IECEX

Over 130 years of tradition, over 130 years of practical approach, competence and experience: STAHL CraneSystems can look back on a history characterised by the constant drive for innovation and significant modernisations. At the end of the nineteen-twenties, STAHL CraneSystems was one of the first, and for some time the only manufacturer to influence and advance the development of explosion-protected lifting technology. Revolutionary and programmatic in many fields, always receptive to new aspects, we have amassed a wealth of experience that gives us distinct advantages today. Profit from these advantages, from the expertise of one of the world's leading manufacturers of explosion-protected components and systems for overhead transportation. Technically and economically, our products not only belong to the top flight internationally but lead the way in the field of explosion protection.

18
76



Company founded
by Rafel Stahl

First large
electric portal
crane

18
98

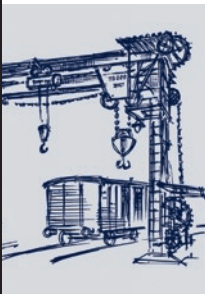

First electric hoist
with wire rope
and drum

19
22

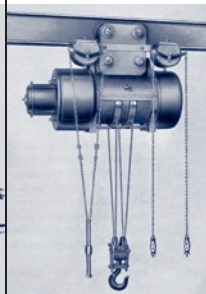

19
26



Development of explosion-protected hoists, crane components and control technology begins

Construction of
explosion-protected
crane systems up to
a lifting capacity
of 100,000 kg for the
chemical industry

19 19
35 53



World innovation: first explosion-protected flameproof enclosed electric wire rope hoist

AS range of wire rope hoists

19 19 19 19
78 83 97 98

ST range of chain hoists

SH range of wire rope hoists

T range of chain hoists



Information and standards

04

Explosion protection

06

Legal principles

08

Physical and technical principles

10

Duties and obligations
of users in Europe

12

Expertise in explosion protection

Products and services

14

The danger points

16

Explosion-protected
wire rope hoists

18

Explosion-protected chain hoists

20

Components and electrics

22

The engineering

24

The support

26

On the spot and in action
all around the world

STAHL CraneSystems implements the ATEX product directive 94/9/EC comprehensively for the whole range of products

20
03



20
09



As explosion protection expert, STAHL CraneSystems offers explosion-protected customised solutions and crane technology for the gas liquefaction industry (LNG)

20
10



STAHL CraneSystems presents the world's largest portfolio of explosion-protected lifting technology, drive technology and control technology

Explosion protection

The beginnings of explosion protection are to be found in the mining industry where miners are exposed to the dangers of fire damp. This term refers to methane gas which escapes in coal mines in particular and which reacts explosively when combined with fine coal dust and air (fire damp explosion). Explosive atmospheres may however occur in other branches of industry too, for example in the chemical or petrochemical industries. Electrical apparatus used in potentially explosive atmospheres must be constructed in such a way that it does not become a source of ignition.

In order to avoid serious injuries and damage to material and the environment, safety regulations, laws, decrees and standards have been established in most states. In this way a high degree of safety has

developed in explosion protection across the world. As the physical laws regarding the occurrence of explosions and the measures taken to prevent them are based on similar principles everywhere, currently the aim is to harmonise approval conditions and regulations regarding conformity at an international level. This brochure merely outlines the European explosion protection directives which however correspond largely to the international IECEx regulations. It cannot take the place of an intensive analysis of national legal principles and standards.

STAHL CraneSystems is pioneering, dynamic and uncompromising when the safety of persons and machines in areas subject to explosion hazards is at stake. STAHL CraneSystems occupies an exceptional position in this field with our many decades of experience and expertise, our own fundamental research

and development, approvals from the Federal Physico-Technical Institute (PTB) and other national and international test institutes and worldwide certification. All hoists and components without exception come from our own production, from motor and brake to controls and control pendant.

STAHL CraneSystems is the world specialist for explosion protection and as world market leader offers the most comprehensive, complete programme of explosion-protected lifting, drive and control technology.

Chemical industry



Petrochemical industry



Food processing industry



Shipbuilding and offshore industry



Pharmaceutical industry



Energy supply

Legal principles

ATEX

With the ATEX product directive 94/9/EC (ATEX 95) and the ATEX user directive 1999/92/EC (ATEX 137) the European Community has established the basis for uniform European explosion protection. This safety concept is applicable both for manufacturing electrical and non-electrical apparatus and for operating this apparatus in the respective industrial plants. The legislators of the individual member countries implement these directives in equivalent statutory regulations.

In Germany for example these are the Explosion Protection Ordinance ExVO (implementation of directive 94/9/EC), the Industrial Safety Ordinance (implementation of directive 1999/92/EC) and the Technical

Regulations for Industrial Safety (TRBS), the regulations issued by the Employers' Liability Insurance Associations (e.g. BGR 104, BGR 109 and BGR 132), the Employers' Liability Insurance Association information sheets (e.g. BGI 740) and the regulations issued by the VDI (Association of German Engineers) (e.g. 2263 and 3673).

ATEX directive 94/9/EC defines the properties required by apparatus for safe use in explosive areas. This includes classification into equipment groups and categories, the respective conformity assessment procedures to be followed, manufacturers' responsibility including CE conformity marking, basic safety requirements for the development and manufacture of explosion-protected equipment

and recognised quality management measures to be implemented during production. ATEX directive 99/92/EC defines the obligations of users and employers for employees' protection in explosive areas. Inter alia, the user must assess risk and classify the potentially explosive areas into corresponding zones so that the apparatus required by directive 94/9/EC can be used in safety.



ATEX

IECEX

Excerpt from ATEX directives



Assessment of conformity in compliance with ATEX 95

Category 1 and M1	EC prototype test (III)	Production quality assurance (IV)		CE
		Product verification (V)		
Individual verification (XI)				
Category 2 and M2	Electrical equipment or Internal combustion engine	EC prototype test (III)	Quality assurance of products (VII)	
			Conformity with prototype (VI)	
Category 3	Other apparatus	In-house production testing (VIII) and documentation at notified body	Individual verification (XI)	
			In-house production testing (VIII)	
			Individual verification (XI)	

The figures in brackets refer to the modules of directive 94/9/EC which define the procedures to be followed for meeting conformity.

IECEX

The international IECEx scheme also aims to assess conformity and certify apparatus, systems and services for use in explosive areas. The IECEx system, introduced in 1996, supports the standardisation of norms and the issuing of certificates of conformity (CoC) unrelated to specific countries or regions, in order to thus simplify the free global movement of goods. There is already extensive agreement as to classes and requirements between the European ATEX directives and the IECEx regulations. This means that ATEX could one day be superseded.

IECEX is of great importance outside Europe. A total of 26 countries have acceded to IECEx and there are 34 recognised IECEx certification

bodies (ExCB) and 36 recognised test laboratories (ExTLs) around the world. In countries which recognise IECEx, apparatus with the corresponding certification can be commissioned without further testing.

All products of STAHL CraneSystems are available also with IECEx certification. You will find further information on the IECEx system and its provisions including regulations, handbooks and procedures at: www.iecex.com

Useful links

ATEX

→ <http://ec.europa.eu/enterprise/atex>

Explosion Protection Ordinance 11th GPSGV)

→ http://bundesrecht.juris.de/gsgv_11
(German)

Technical Regulations for Industrial Safety (TRBS)

→ <http://www.baua.de/en>

Industrial Safety Ordinance (BetrSichV)

→ <http://bundesrecht.juris.de/betrSichV>
(German)

Regulations and information sheets of Employers' Liability Insurance Associations

→ <http://www.bghm.de>
(German)

VDI regulations

→ <http://www.vdi.eu>

International Electrotechnical Commission System for Certification to Standards Relating to Equipment for use in Explosive Atmospheres (IECEX)

→ <http://www.iecex.com>

Explosion protection



International testing authorities



Physical and technical principles





An explosion is a precipitate chemical reaction of combustible matter with oxygen setting free high energy. In this connection, combustible matter may be gases, mists, vapours or dusts. An explosion can only take place if three factors come together: combustible matter (in suitable dispersion and concentration), oxygen (in the air) and a source of ignition (e.g. an electric spark).

It is thus necessary to prevent ignition or reduce the effect of an explosion to an innocuous level. To ensure this, apparatus which is used in potentially explosive atmospheres must be designed, manufactured and of course marked in compliance with the relevant regulations (ATEX product directive 94/9/EC, IECEx

regulations, etc.). Classification of devices into groups and categories according to ATEX product directives or in EPL according to IECEx standards results from their area of use or the safety level of protective measures and the frequency of occurrence of an explosive atmosphere. The highest possible risk potential must be taken into account when carrying out this classification. Only explosion-protected apparatus may be used in areas in which explosive atmospheres may occur in spite of all preventive measures. This apparatus is produced in various types of protection in accordance with the corresponding construction regulations (series of standards IEC/EN 60079, IEC/EN 61241 and

EN 13463). The type of protection applied by the manufacturer depends on the type and function of the apparatus. All standardised types of protection within a category are equivalent. In the EG declaration of conformity included in the technical documentation the manufacturer confirms that the product meets the ATEX directives.

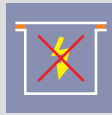
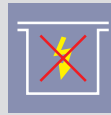
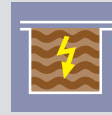
IEC/EN 60079 for equipment in areas subject to gas/dust explosion hazards

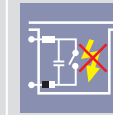
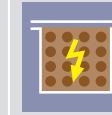
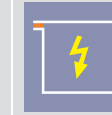
									
Ex d flameproof enclosure	Ex p pressurised apparatus	Ex e increased safety	Ex n Zone 2 equipment	Ex o oil immersion	Ex m encapsulation	Ex op optical radiation	Ex i intrinsic safety	Ex q powder filling	Ex t protection by housing
IEC 60079-1 EN 60079-1	IEC 60079-2 EN 60079-2	IEC 60079-7 EN 60079-7	IEC 60079-15 EN 60079-15	IEC 60079-6 EN 60079-6	IEC 60079-18 EN 60079-18	IEC 60079-28 EN 60079-28	IEC 60079-11 EN 60079-11	IEC 60079-5 EN 60079-5	IEC 60079-31 EN 60079-31

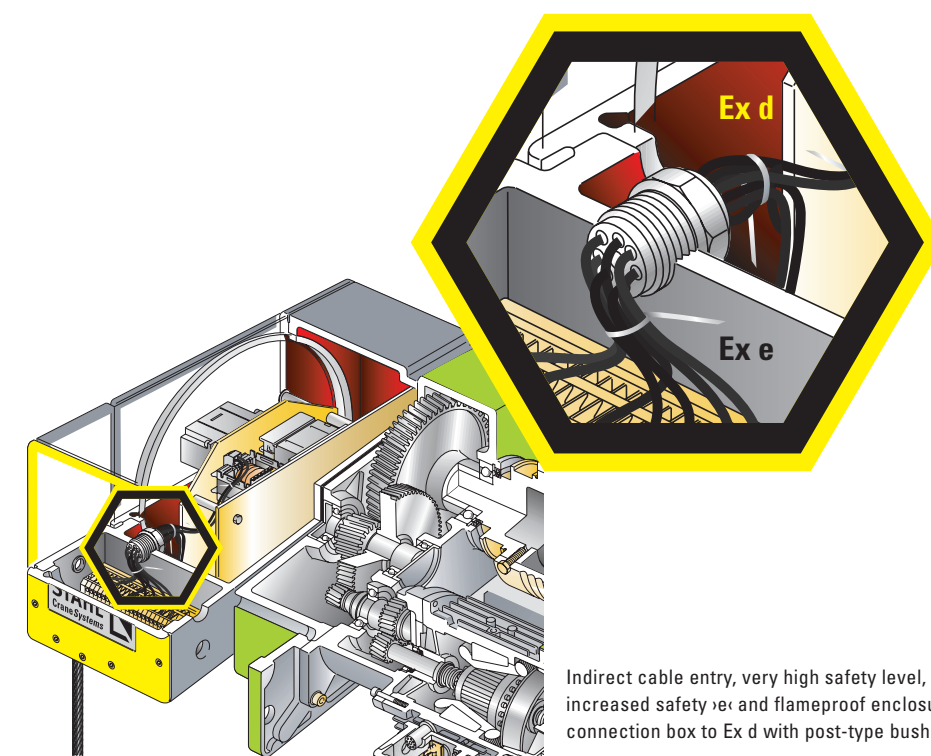
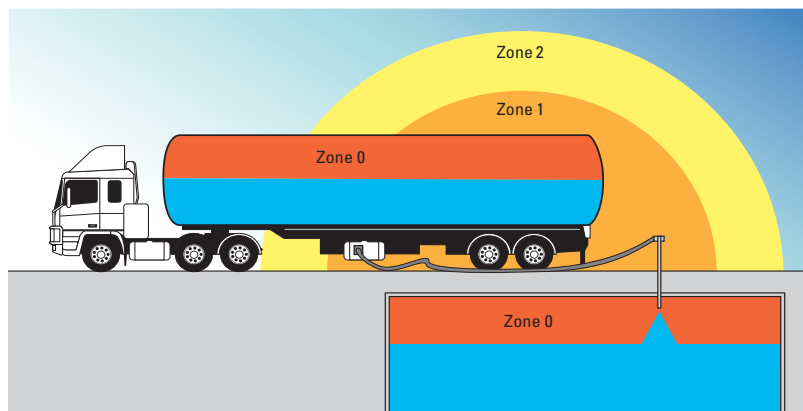
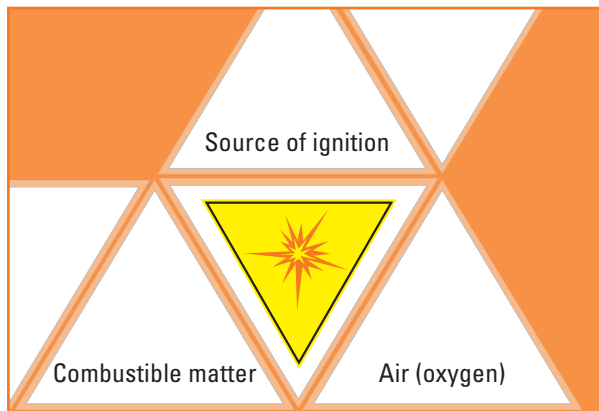

Indirect cable entry, very high safety level, provided by type of protection increased safety »e« and flameproof enclosure »d«. Connection of Ex e connection box to Ex d with post-type bushing.

EN 13463 for non-electrical equipment in areas subject to gas/dust explosions

IEC/EN 61241 for equipment in areas subject to dust explosions

* applicable up to 01.10.2012

Ex b monitoring sources of ignition	Ex c constructional safety	Ex fr restricted breathing apparatus	Ex k liquid immersion	Ex d flameproof enclosure	Ex p pressurised apparatus	Ex tD protection by housing*	Ex iD intrinsic safety	Ex pD pressurised apparatus	Ex mD encapsulation*
EN 13463-6	EN 13463-5	EN 13463-2	EN 13463-8	EN 13463-3	EN 13463-7	IEC 61241-1 EN 61241-1	IEC 61241-11 EN 61241-11	IEC 61241-4 EN 61241-4	IEC 61241-18 EN 61241-18

Duties and obligations of users in Europe

ATEX directive 1999/92/EC defines users' obligations for the protection of employees working in potentially explosive atmospheres. The user is obliged to establish technical and organisational measures to prevent explosions occurring. In this respect he must for example assess the potential danger and explosion risk, ensure that the working environment has been designed for safety and classify the hazardous areas into zones in accordance with the directives for safe operation of the apparatus which has been classified into categories. In addition he is

obliged to issue and maintain an explosion protection document. Naturally further issues are defined in directive 1999/92/EC in order to implement explosion protection effectively. After a system has been commissioned in due form it must be monitored and maintained so that the safe condition of the system is ensured and all dangers can be excluded. The plant's expert has product-specific documents (rating plate, operating instructions, EC prototype test certificate, declaration of conformity, etc.) and universally valid documents (legal ordinances, industrial safety ordinance, technical regulations TRBS, norms and standards, etc.)

at his disposal. The full product-specific documentation must be managed and retained throughout the period of use of the apparatus and placed at the disposal of the experts entrusted with maintenance work.

Zone plan of a paint shop

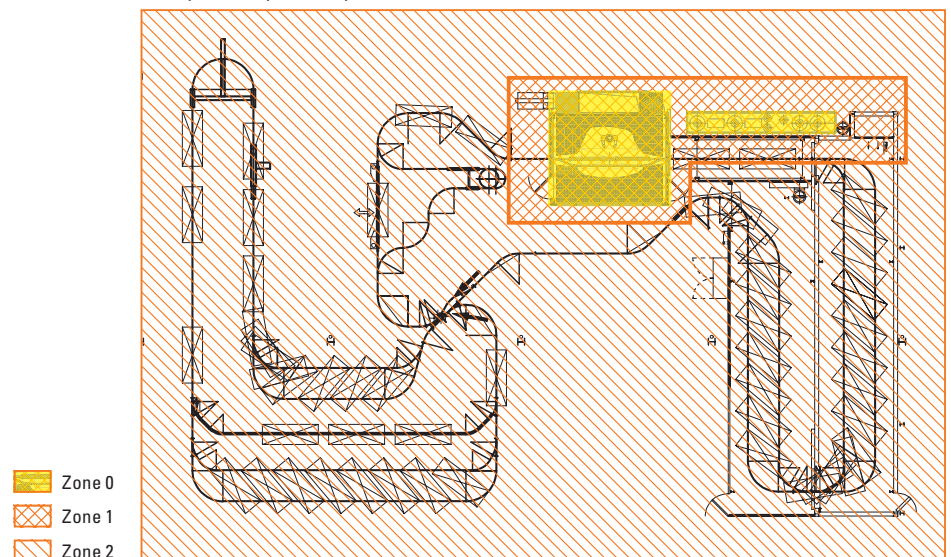

Integrated explosion protection

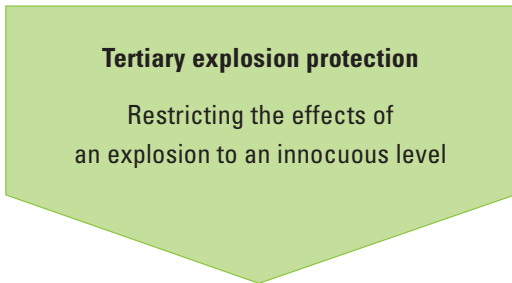
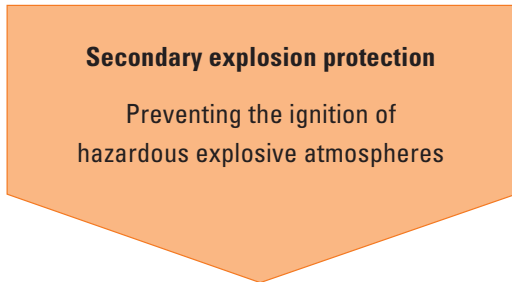
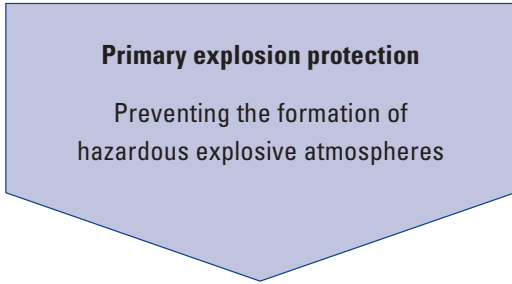

Risk diagram

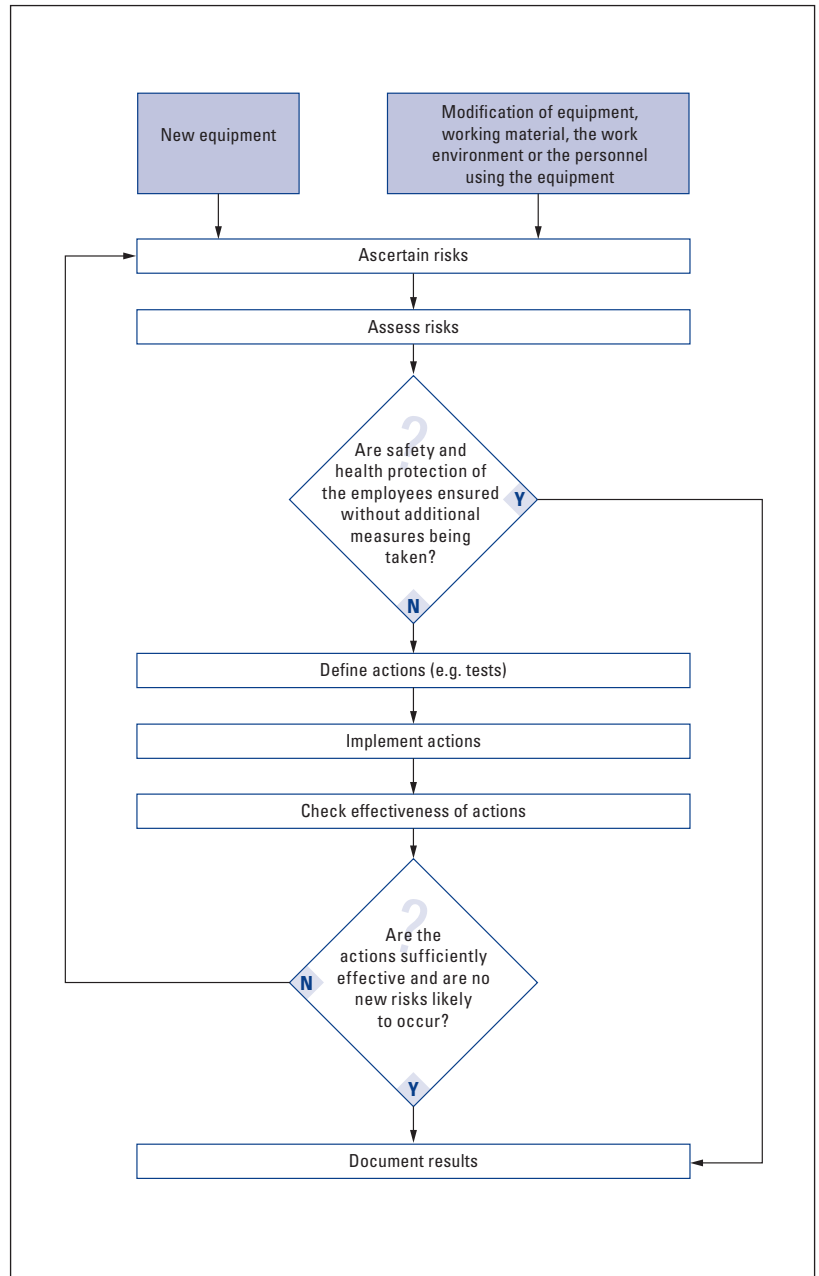

Expertise in explosion protection

As the world's leading manufacturer of explosion-protected lifting technology and explosion-protected crane components, STAHL Crane-Systems offers the widest complete portfolio and most comprehensive services in this field. Explosion-protected products from STAHL Crane-Systems meet not only German national laws and European ATEX directives but also international standards and laws for the American and Asian market. For example, all products are certified both to ATEX and IECEx.

Our product types are certified after passing an EC prototype test and undergo the conformity assessment procedure specified in the directives. Development and manufacture of the series products are subject to our strict quality management monitored by independent European inspection authorities. The test certificates from the notified European inspection authorities are recognised throughout the EU. The rating plates indicate in addition to the usual data (manufacturer, type, serial number,

electrical data) the data relevant to explosion protection. CE marking of the products, declaration of conformity in writing and detailed operating instructions and documentation confirm that all valid EC directives applicable to the apparatus are observed.

Decades of experience in the field of explosion protection, responsible, expert staff and production in accordance with the latest directives and standards guarantee quality down to the last detail for every piece of explosion-protected equipment from STAHL CraneSystems.



Specific marking of explosion-protected devices (current marking)

CEN/CENELEC/IEC	Ex	mb	IIB	T4	Gb
<p>Symbol for explosion protection (for electrical apparatus only)</p> <p>Types of protection: Ignition source monitoring – b Constructional safety – c Flameproof enclosure – d, db Increased safety – eb Restricted breathing enclosure – fr Intrinsic safety – ia, ib, ic Liquid immersion – k Encapsulation – ma, mb Type of protection γnc – nAc, nCc, nRc Oil immersion – ob Pressurised enclosure – p, pxb, pyb, pzc Powder filling – qb Protection by housing – ta, tb, tc</p>					<p>(as required) EPL (equipment protection level): G – Gas D – Dust a – Very high safety level b – High safety level c – Extended safety level</p>
<p>Gas group: e.g. propane – IIA e.g. ethylene – IIB e.g. hydrogen – IIC</p>		<p>Dust group: combustible flakes – IIIA non-conductive dust – IIIB conductive dust – IIIC</p>		<p>Gas: temperature classes – max. surface temperature T1 – 450 °C T3 – 200 °C T5 – 100 °C T2 – 300 °C T4 – 135 °C T6 – 85 °C</p> <p>Dust: specification of max. surface temperature in °C (as required)</p>	

ATEX (EU directive 94/9/EG)	CE	⊕	II	2	G
<p>CE marking</p> <p>Explosion protection symbol</p> <p>Equipment group: mining – I Other potentially explosive atmospheres – II</p>					<p>Type of explosive atmosphere for Group II</p> <p>G Gases, vapours, mists Zone 0, 1, 2</p> <p>D Dust Zone 20, 21, 22</p>
<p>Equipment category for Equipment Group II:*</p>		<p>very high safety level – 1 high safety level – 2 normal safety level – 3</p>			
<p>* for Equipment Group I: M1, M2</p>					

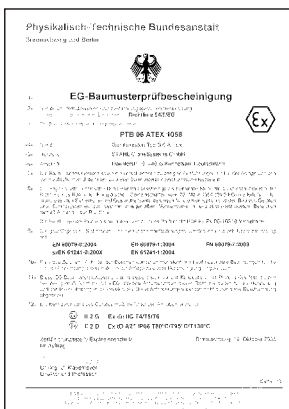

Operating instructions – contents in accordance with IEC/EN 60079-0 and IEC/EN 61241-0

Commissioning
Use
Installation and dismantling
Maintenance
Electrical installation
Electrical parameters
Particular conditions

The danger points

In lifting, drive and control technology both electrical and non-electrical components and parts can trigger an explosion. STAHL CraneSystems therefore offers apparatus specially designed for use in areas subject to gas or dust explosion hazard. All hoists and crane components without exception are from our own production, from motor and brake to controls and switchgear, and meet the latest European (ATEX) and international (IECEx) construction and safety regulations for potentially explosive atmospheres.

1 Wheels



The type of protection of all wheels is constructional safety »c«. If travel speeds are high, this also includes brass wheels.

2 Rope guide/chain guide

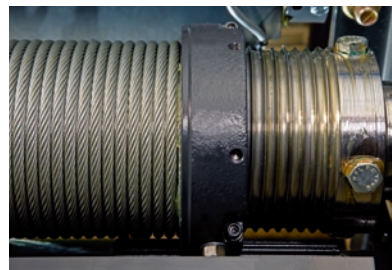

The wear-resistant rope guide in nodular graphite casting GJS (previously designated GGG) is extremely durable and not subject to temperature limitations. The same applies to the chain guide, type of protection used: constructional safety »c«.

3 Gear



The types of protection of the gear are constructional safety »c« and liquid immersion »k«. The protective liquid (oil) prevents sparks.

4 Equipotential bonding

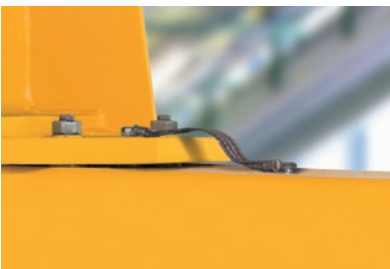

Equipotential bonding is essential for avoiding incendive sparks when installing crane technology in potentially explosive atmospheres.

5 Overload device

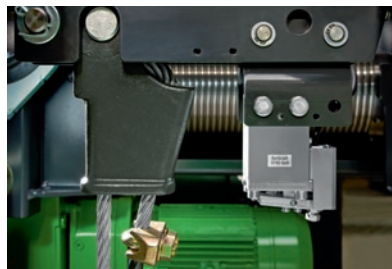

The overload devices for Zone 1 and 21 comprise mechanical sensors (LMS), analog sensors (LET) for Zone 2 and 22.

6 Panel box



The type of protection for panel boxes for Zone 1, 2 and 21 on cranes and hoists combines types of protection flameproof enclosure »d«, increased safety »e« and protection by housing »tD«.

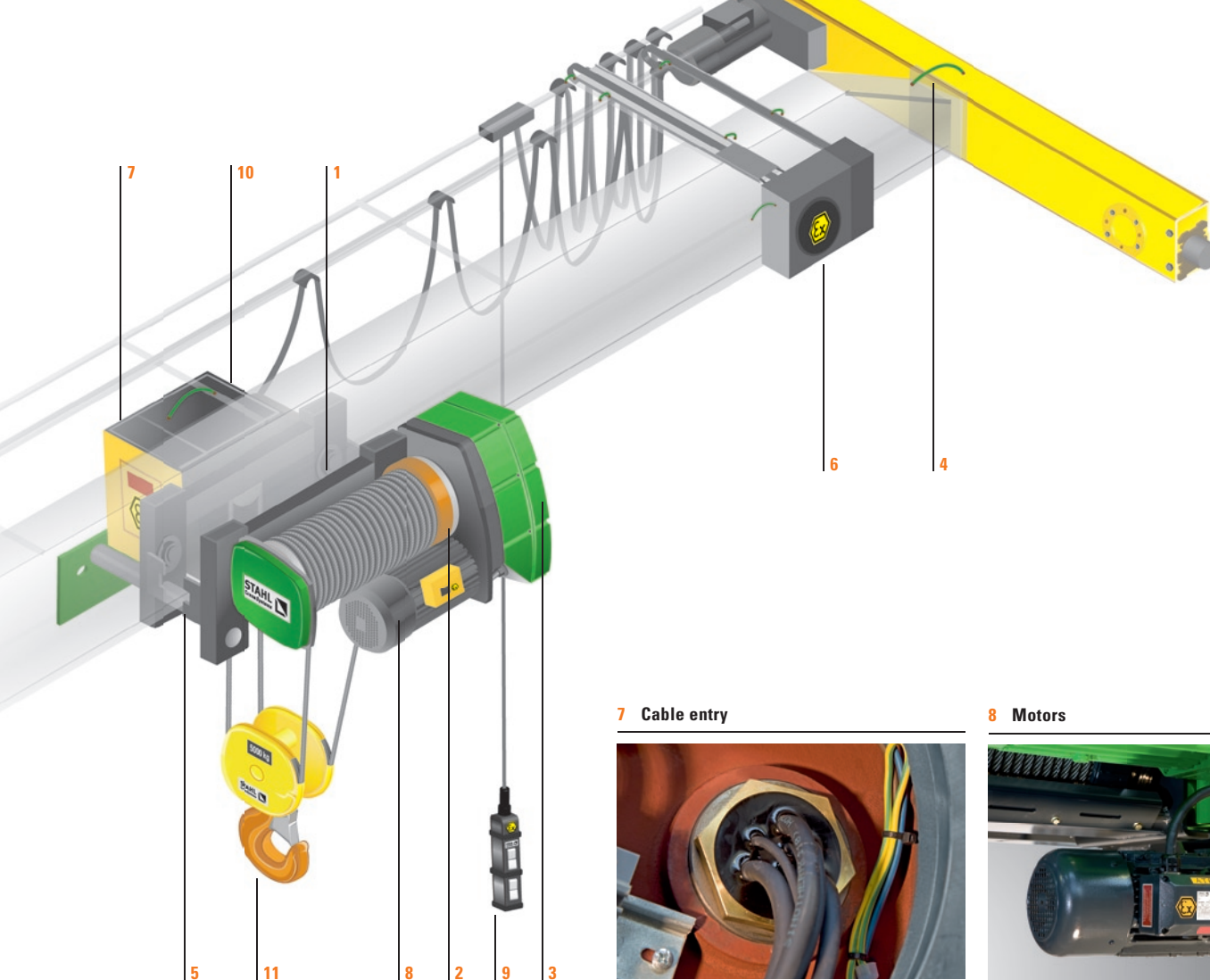

7 Cable entry



Indirect cable entry, very high safety level from type of protection increased safety »e« and flameproof enclosure »d«. Connection of the Ex e connection box to Ex d by post-type bushing.

8 Motors



Motors for Zone 1 and 21 are made of grey cast iron, the type of protection combines flameproof enclosure »d«, increased safety »e« and protection by housing »tD«. For Zone 2 the motors are made of aluminium and in type of protection non-sparking equipment »nA«. For Zone 22 the motors are manufactured in IP 66 and protection by housing »tD«.

9 Control pendant



The type of protection of the housing is IP 66, installed elements protected by flame-proof enclosure »d«, increased safety »e« and protection by housing »tD«.

10 Limit switch



The type of protection of the limit switch combines flameproof enclosure »d«, increased safety »e« and protection by housing »tD«.

11 Bottom hook block



The type of protection employed is constructional safety »c«, no aluminium is used. If travel speeds are high, individual parts, such as the load hook, are bronze-coated.

Explosion-protected wire rope hoists

The SH ex and AS7 ex explosion-protected wire rope hoists from STAHL Crane-Systems meet EC product directive 94/9/EC (ATEX 95) and the international IECEx regulations. They are constructed for use in Zone 1 or Zone 21, however they can also be used in Zone 2 or Zone 22.

These adaptable wire rope hoists are of systematically modular construction and designed for a load capacity range of 1,000 kg to 160,000 kg. For the load capacity range of 1,000 kg to 25,000 kg the versatile SH ex series is available in five frame sizes with 15 load capacity brackets. The upper load capacity range up to 100,000 kg is covered by the field-proven AS7 ex and AS7 ex ZW series. The SHW ex and SW ex winch programme extends the range of applications in the high-load bracket up to 160,000 kg.

The attractive design of STAHL CraneSystems' wire rope hoists conceals a compact, robust construction which is largely low-maintenance. They are extremely reliable and have a longer-than-average service life. Common to all of them is the particularly smooth precise starting and braking characteristic.

The facts

- Condition monitoring apparatus in explosion-protected design ensures safe operation
- Electronic motor and brake management guarantees a long service life
- Most comprehensive explosion-protected wire rope hoist programme for the load capacity range from 500 kg to 160,000 kg
- Equipped as standard with two hoisting and two travelling speeds
- High standard classification in accordance with FEM

Standard classifications in accordance with FEM

Type	Reeving	Load capacity [kg]																	
		1,000	1,250	1,600	2,000	2,500	3,200	4,000	5,000	6,300	8,000	10,000	12,500	16,000	20,000	25,000	32,000	40,000	50,000
SH 3	2/1, 4/2	3m	2m	2m															
	4/1				3m	2m	2m												
SH 4	2/1, 4/2			3m	2m	2m	1Am												
	4/1						3m	2m	2m	1Am									
SH 5	2/1, 4/2						3m**	2m	2m	1Am									
	4/1									3m	2m	2m	1Am						
SHR 6	2/1							2m	2m	1Am									
	4/1										2m	2m	1Am						
SH 6	2/1									3m	2m	1Am							
	4/1											3m	2m	1Am					
	4/2									2m	2m	1Am							
AS 7	2/1											3m	2m	1Am	1Bm*				
	4/1														3m	2m	1Am	1Bm*	

* for Zone 2, 22 only ** with 2/1 reeving, for Zone 1, 21 only

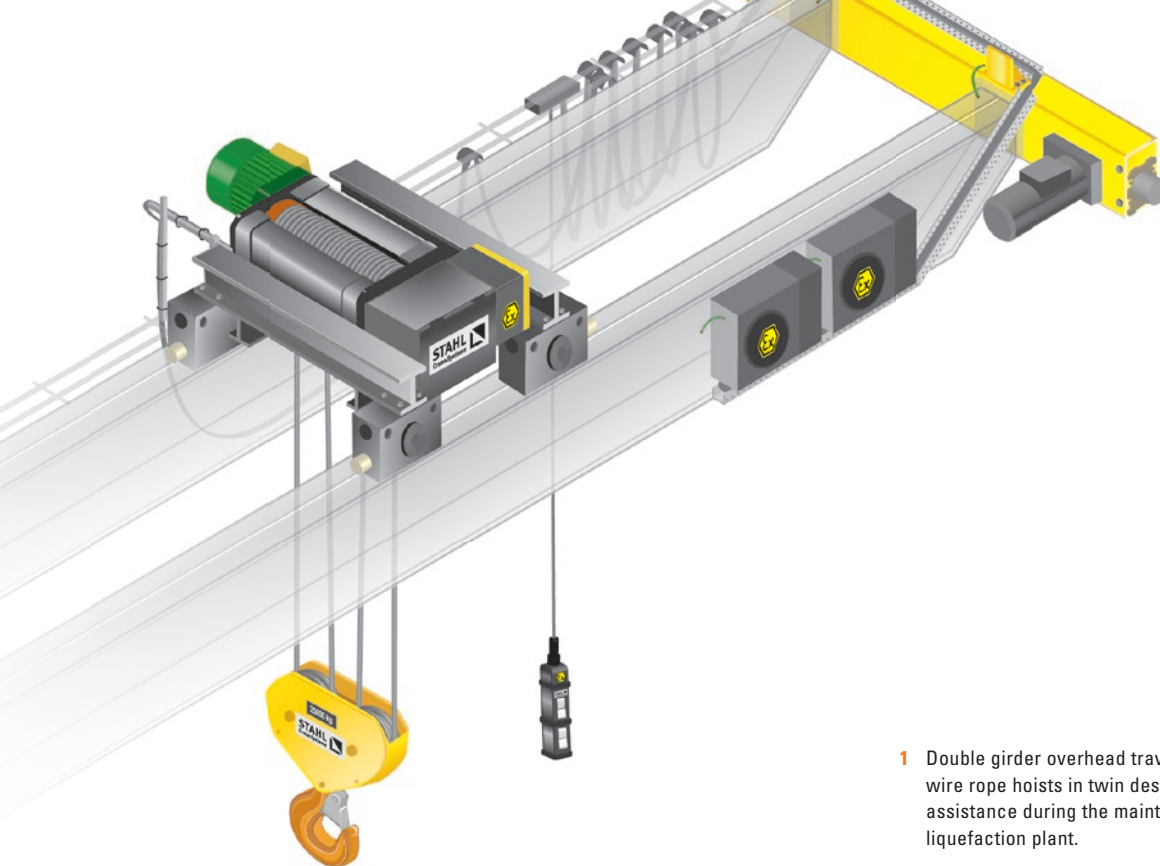

- 1 Double girder overhead travelling cranes with explosion-protected wire rope hoists in twin design with auxiliary hoist provide assistance during the maintenance of compressors in a hydrogen liquefaction plant.
- 2 SH ex wire rope hoists are available for Zone 1 and Zone 2, and for Zone 21 and Zone 22. They reliably meet the technical, normative and practical requirements specified by ATEX and IECEx.



1

2

Use	Category	Protection against	Explosion protection class
Zone 1	Ex II 2 G	Gas	Ex de IIB T4 or Ex de IIC T4
Zone 2	Ex II 3 G	Gas	Ex de nA IIB T3 (T4) or Ex de nA IIC T3 (T4)
Zone 21	Ex II 2 D	Dust	Ex tD A21 IP 66 T 120 °C
Zone 22	Ex II 3 D	Dust	Ex tD A22 IP 66 T 120 °C

Explosion-protected chain hoists

The STex explosion-protected chain hoists from STAHL CraneSystems meet EC product directive 94/9/EC (ATEX 95) and the international IECEx regulations. They are specially constructed for use in Zone 1 or Zone 21, however they can also be used in Zone 22. The mechanical design is prototype-tested: TÜV10ATEX7642x.

This series of chain hoists belongs to the most distinctive and comprehensive on offer in the world. In use in thousands of applications for decades, modernised and optimised again and again, this chain hoist is a classic, powerful, reliable and undemanding as regards maintenance and power consumption. The STex series is available in 13 load capacity brackets from 125 kg to 6,300 kg. It can be used as stationary hoist with suspension hook or eye, rigid suspension, or with push or electric trolley, and is particularly suitable for rugged use in industry. The innovative and pioneering design of the chain hoist brings considerable economic advantages. The extremely short headroom available as an option for every type of chain hoist optimises the effective hook height while minimising wear on the chain. In addition to standard versions, further off-standard versions and customer-specific solutions are available.

The facts

- Patented suspension directly on the chain guide
- The most comprehensive explosion-protected chain hoist programme for the load capacity range from 125 kg to 6,300 kg
- Maximum utilisation of space thanks to the extremely short and compact headroom dimensions
- Standard classification in accordance with FEM

Standard classifications in accordance with FEM

Type	Reeving	Load capacity for Zone 1 and 21 [kg]								Load capacity for Zone 22 [kg]													
		250	500	1,000	1,600	2,000	2,500	3,200	5,000	125	250	320	500	630	1,000	1,250	1,600	2,000	2,500	3,200	5,000	6,300	
ST 05	1/1									3m/2m	1Am	1Bm											
	2/1												1Am	1Bm									
ST 10	1/1												1Am										
	2/1														1Am								
ST 20	1/1	3m	3m	1Am											2m/1Am								
	2/1		3m	3m	2m	1Am									3m		2m/1Am						
ST 30	1/1															1Bm							
	2/1																			1Bm			
ST 32	1/1														3m	2m/1Am							
	2/1																			2m/1Am			
ST 50	1/1					2m	1Am												1Am				
	2/1							2m	1Am												1Am		
ST 60	1/1																				1Bm		
	2/1																					1Bm	

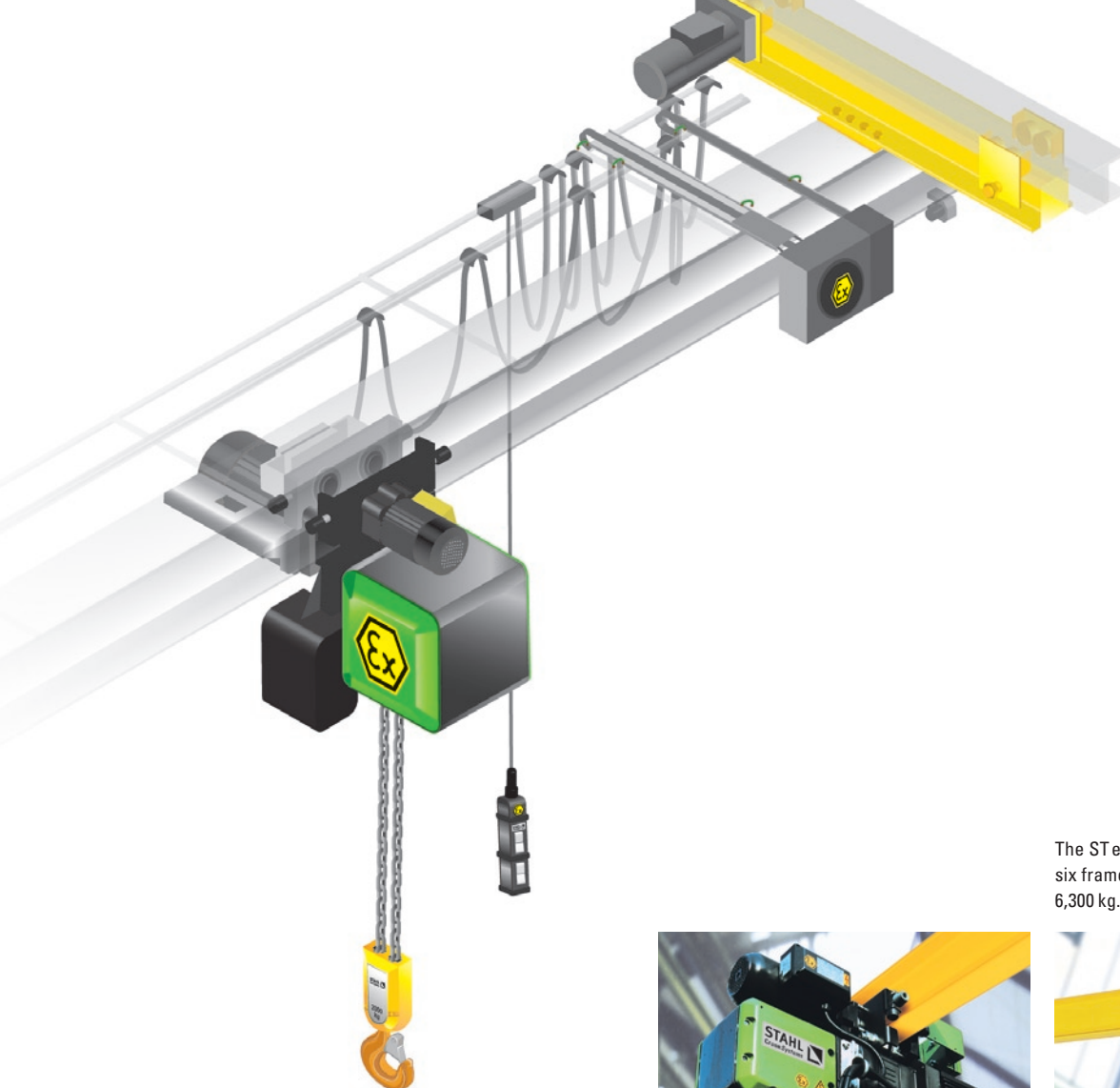

The ST ex chain hoist for Zone 22 is available in six frame sizes up to a load capacity of 6,300 kg.



The STex chain hoist for Zone 1 and Zone 21 is available in two frame sizes up to a load capacity of 5,000 kg.



Use	Category	Protection against	Explosion protection class
Zone 1	Ex II 2 G	Gas	Ex de IIB T4 or Ex de IIC T4
Zone 21	Ex II 2 D	Dust	Ex tD A21 IP 66 T 120 °C
Zone 22	Ex II 3 D	Dust	Ex tD A22 IP 66 T 120 °C

Components and electrics

The components and electrics, which also meet both EC product directive 94/9/EC (ATEX 95) and the international IECEx regulations, are the perfect complement to explosion-protected lifting technology from STAHL CraneSystems.

The correct functioning and high performance of a crane system depend on the quality of all its components. These are developed down to the last detail by STAHL CraneSystems and supplied from our own production. Forward-looking, high-quality modules complement one another in the system and ensure both safety and cost-effectiveness. Using the modular components, our crane manufacturing partners in your region are able to adapt the crane system individually to customer-specific requirements and wishes.

Mature, cost-effective electronics, drive technology to meet the highest demands, innovative modules and field-proven, robust standard components are available for these adaptations. The expert crane manufacturing partners and experienced system manufacturers are trained by STAHL CraneSystems' explosion protection experts so that they are always up to date as regards the status of national and international regulations and state-of-the-art technology.

Bottom hook block



For high and very high travelling speeds the load hook and the solid parts of potential impact surfaces are bronze-coated. In addition, all other exterior surfaces of the bottom hook block can be bronze-coated to prevent sparking.

Explosion-protected crane endcarriages	For single-girder overhead travelling cranes, 7 wheel diameters and 5 wheelbases
	For double-girder overhead travelling cranes, 7 wheel diameters and 6 wheelbases
	For single-girder suspension cranes, 4 wheel diameters and 3 wheelbases
Explosion-protected drive technology	Supplied as standard with 2-step speeds 20/5 m/min or 40/10 m/min, other speeds on request
	As an option, stepless speed control
Explosion-protected control technology	SWH 5 ex wired control pendant
	Panel box in explosion-protected design
Explosion-protected electrics	Festoon cables in conjunction with control pendants or radio remote controls

Panel box

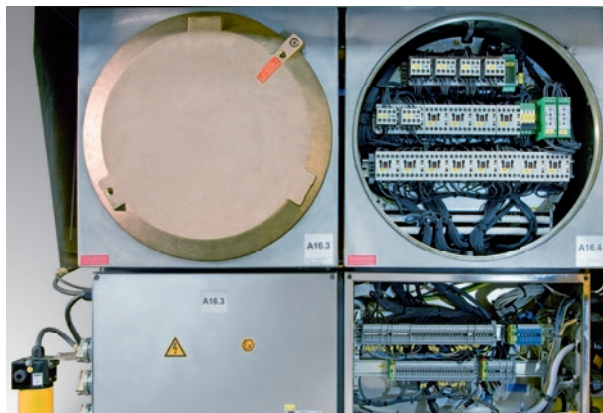

Flameproof enclosure for Zone 1 and Zone 2: the sheet steel or aluminium housings can be used as individual housings or in combination. All components required such as transformers, contactors, fuses, measuring instruments and tripping devices can be installed in the modular-design housing. Post-type bushings provide the connection to the terminal box (in increased safety Ex e).

Travel drive



The explosion-protected travel drives Zone 1 and Zone 21 are designed for intermittent operation. They have a sliding rotor brake motor with conical brake and centrifugal mass for smooth starting and braking characteristics. All motors are pole-changing providing two travel speeds. The particularly quiet gear requires little maintenance thanks to its long-term oil bath lubrication.

Crane endcarriages



Crane systems up to a load capacity of 50,000 kg and with spans of up to 30 m can be built with explosion-protected endcarriages for suspension and overhead travelling cranes. For particular applications, at customers' request and for increased safety all wheels can be supplied in brass.

Control pendants



The SWH 5 ex control pendants are designed specifically for controlling hoists and cranes in hazardous areas. Activation is generally 2-step and permits a quick changeover from 'fast' to 'slow' and vice versa. All control pendants are equipped with an EMERGENCY STOP slam button meeting the requirements of IEC/EN 60947-5-5.

The engineering

Engineering means innovation and individuality. Constantly redefining the lifting and transporting of loads for complex requirements even in explosive areas is a job for our experts. From one of the widest product ranges of standard components they regularly develop modern, individual explosion-protected customised solutions which meet all national and international directives and laws. The whole portfolio and all customised solutions are available in explosion-protected designs for Zone 1, Zone 2, Zone 21 and Zone 22.

Hardly any other manufacturer of lifting and crane technology can offer you this diversity of precisely designed explosion protection solutions in the highest quality and cost-effectiveness. Our products rank among the safest technology, in particular in the chemical, petrochemical and pharmaceutical industries, the food processing industry, power supply, shipbuilding, offshore and natural gas liquefaction industries (LNG).

The facts

- Perfectly matched to your product
- Every hoist is the result of over 130 years of experience and expertise
- Short development time
- Cost-effective thanks to modular system
- Technically mature thanks to the use of field-proven standard components
- High quality and reliability ensured by in-house production in Germany



LNG

The LNG hoists from STAHL CraneSystems have been designed especially for maintenance work in natural gas liquefaction plants (LNG). Thanks to their high-quality components and robust design they are ideal for use near the coast in challenging climate conditions.

The pumps which pump the liquid natural gas into a pipeline system at a temperature of -161°C must be lifted out of the tanks and transported to the outside for maintenance up to five times a year. The extreme conditions prevailing in the tank necessitate special ropes which are permanently connected to the liquid gas pump. When maintenance is required, these ropes are attached to the wire rope hoist by means of a rope clamp, so that no hook is necessary. All safety-relevant components are doubled. This means that the hoisting procedure proceed without disruption even if a rope should break. One of the two wire rope hoists lifts the pump, the second hoist runs alongside with a dead rope as backup. If the load rope should break during the hoisting procedure, the second wire rope hoist carries on hoisting. The shock-absorbing rocking suspension of the hoist cushions the impact of the abrupt load change.

Thanks to their redundant design and rocking suspension, STAHL CraneSystems' LNG wire rope hoists are regarded as the safest hoists presently available on the market.

The facts

- Constructed from field-proven series components
- Hoist, gear, drum and motor doubled up
- Off-standard ropes connected by rope clamps
- Special recess in the drum for the rope clamp
- Design minimises risk if a rope should break
- Integrated load sensors monitor the suspended load
- Reliable, high-performance, low-maintenance, mechanisms classified in accordance with FEM
- Special-purpose equipment for use in LNG plants
- Approvals to ATEX and IECEx standards

→ Please order our special brochure on the subject of LNG



Maximum safety level 3B: normal operation even after rope breakage

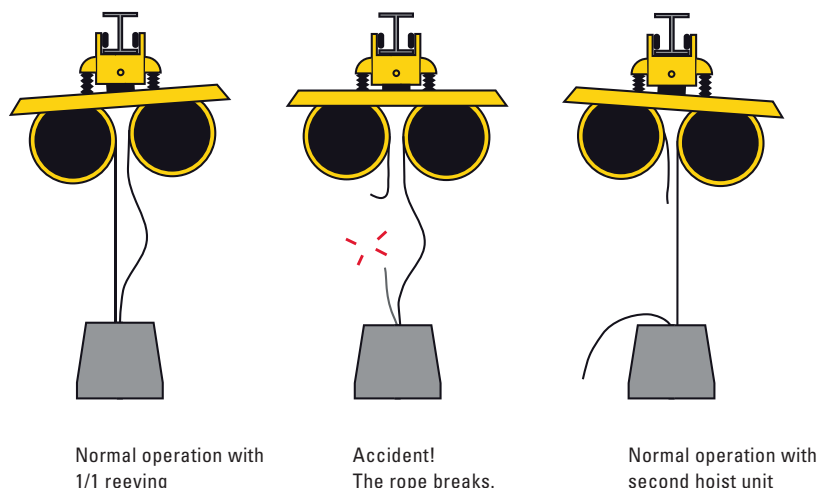

The support

Quality right down to the most minor detail is the standard STAHL CraneSystems is committed to. Not only in the field of crane technology, but also on the subject of support. You will find lifting and crane technology from STAHL CraneSystems all around the world. Developed by engineers and experts, manufactured with maximum care following our well-known standard of quality. All around the world, many companies from various fields have decided on maximum safety and quality, on products from STAHL CraneSystems.

When it comes to sales, we are committed exclusively to capable, professional crane manufacturing partners. You can expect optimum support from them when your individual crane system with components from STAHL CraneSystems is at stake. Consulting and erection of a new system, system-oriented testing and maintenance, modernisation, spare parts supply and training courses. Together with our subsidiaries and crane manufacturing partners we offer you perfectly coordinated support all over the world.





Spare parts – accessible right around the clock

Our own subsidiaries and numerous partners around the world ensure reliable spare parts supply and expert assistance in your area. Even decades after a series has been discontinued, spare parts are available all over the world right around the clock.



Training courses

We constantly keep our regional crane manufacturing partners up to date with training courses, seminars and information material. You too can profit directly from our expertise. We impart practical and theoretical knowledge in our own training centre or on your premises. The seminars on offer in the form of individual, basic and advanced courses cover all main product groups. However we would also be pleased to match a special programme to your individual specifications and requirements.

You will find our current seminar programme at www.stahlcranes.com/en/support



Factory service centre – in action all over the world

Our factory service centre is a service for our customers: wherever you are we assist your crane or systems manufacturer with our experience and expertise whenever he needs us. Up-to-date diagnostic apparatus and condition monitoring systems stand by to support professional service and maintenance work. Not only you, but your system too, are in safe hands. You can rely on us.

You will find our online service at www.web.stahlcranes.com and you can reach our factory service centre on customer.service@stahlcranes.com



On the spot and in action all around the world



- 1 An explosion-protected ST 20 chain hoist with a load capacity of up to 1,600 kg is used for outdoor maintenance work in a chemical plant. The narrow construction of the explosion-protected chain hoist enables the whole width of the crane bridge to be utilised. The suspension crane endcarriages are naturally also in explosion-protected design.
- 2 An explosion-protected SH ex wire rope hoist transports goods through a shaft over several storeys of a chemical plant. The single-girder overhead travelling crane with a load capacity of 5,000 kg is operated by radio remote control.
- 3 The explosion-protected SH ex wire rope hoist is mounted on a double girder overhead travelling crane and intended for outdoor use in a chemical plant. Both hoist and control are in thermally insulated housings enabling the crane to be operated safely down to -40°C .



In action all around the world

You will find explosion-protected lifting and crane technology from STAHL CraneSystems all around the world. Our universally connected network of subsidiaries and partners enables us to be directly in your vicinity and yet to act globally. We would like to list here just a few of the companies which have decided on maximum safety and quality, on products from STAHL CraneSystems.



Europe	Asia	Africa
ABB Lummus Global GmbH, Germany	Alla Co., Thailand	BP Exploration, Algeria
ABB Lummus Global GmbH, Spain	Daelim Engineering Co., Iran	Cullum Detuners Limited, Nigeria
AkerKvaerner (Houston, USA), Italy	Ethylene Malaysia Sdn Bhd, Malaysia	El Djazairia El Omania Lil Asmida SpA, Algeria
Borealis, Germany	Formosa Plastics Corporation, Taiwan	Mitsubishi Heavy Industries, Algeria
BP CHEMBEL N.V., Belgium	Foster Wheeler, Malaysia	Mobil, Nigeria
Cobra Plantas Industriales, Spain	GS Engineering and Construction Corp., Thailand	Tecnicas Reunidas (Spain), Algeria
Eastern Petrochemical Co (Linde), Germany	Hercules Chemical (Nanjing) Co., Ltd, China	TFT Argelia, Algeria
Fluor, Germany	Iran Chemical Industries Investment Co., Iran	North America
Fluor Daniel B.V., Norway	Jacobs Engineering, Singapore	AKER Kvaerner Contracting, USA
Fluxys Refinery, Belgium	JGC Corporation (Japan), Oman	Noble Drilling, USA
Intecsa Industrial, Spain	Kuwait National Petroleum Co., Kuwait	South America
Jacobs Engineering, Germany	MAN Ferrostaal Essen, Oman	Atlas Methanol Company, Trinidad and Tobago
Motor Oil (Hellas) Refineries Corinth, Greece	MaisonWorleyParsons (Shanghai), China	Ferrostaal (Germany), Trinidad and Tobago
OMV Burghausen, Germany	Mitsubishi Heavy Industries, Brunei	HDTHCK UTE, Chile
Repsol Petroleo S.A. Petronor, Spain	PT Wiryia Krenindo Perkasa, Indonesia	KÜTTNER, S.A. (Germany), Mexico
Repsol YPF/Petronor, Spain	Qatar Petroleum Dolphin Energy Co., U.A.E.	UTE Coker Aconcagua I, Chile
Sagas, Spain	Ras Laffan Olefins Company Limited (RLOC), Qatar	Australia
Saipem S.A. (Technigas), Belgium	Samsung, Saudi Arabia	Kellogg Joint Venture, Australia
Scanraff Refinery (PREEM), Sweden	Saudi Petrochemical Company, Saudi Arabia	Woodside Energy Ltd., Australia
Sparrows Offshore Services Ltd, Great Britain	SembCorp Simon Carves (UK), China	
Statoil, Norway	Singapore Refining Co., Ltd (SRC), Singapore	
Technip, Belgium	Sparrows Offshore Services Ltd., Azerbaijan	
Ticona, Germany	Technip France (Paris), Qatar	
Total Refinery (Antwerp), Belgium	The Kuwait Olefins Company (TKOC), Kuwait	
Turkiye Petrol Rafinerileri A.S., Turkey	ToyoThai (Bayer BPA, Thailand), Thailand	
voestalpine AG (Linz), Austria		

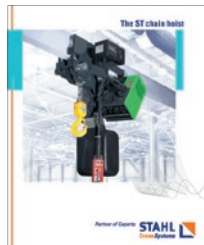

Presented by

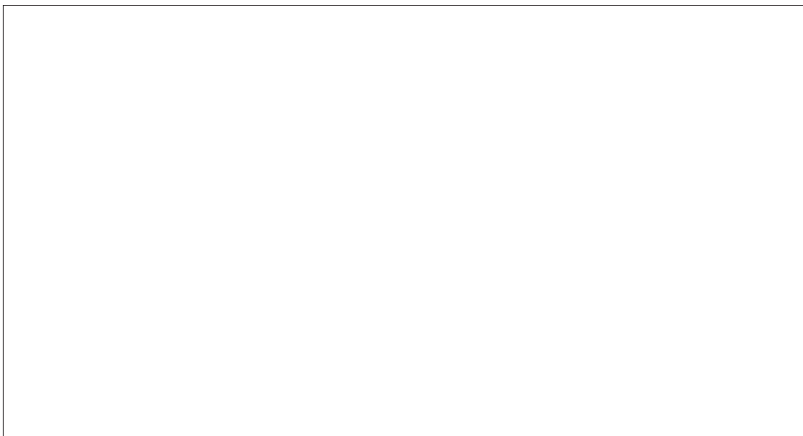

➔ www.stahlcranes.com

STAHL CraneSystems GmbH
Daimlerstr. 6, 74653 Künzelsau, Germany
Tel +49 7940 128-0, Fax +49 7940 55665
marketing@stahlcranes.com

Partner of Experts

